

17 861 625













- 145mm projection
 - rigid, thermally insulated spout
 - laminar flow
 - height of mixer 249 mm
 - height up to laminar flow regulator 184 mm
 - hole diameter 35 mm
 - provides filtered, hot water up to 93°C
 - provides filtered, cold water
 - max. flow 2 l/min at 3 bar flow pressure
 - ready-to-use control unit for wall mounting (137mm x 159mm x 60mm)
 - electronic magnetic valve
 - 100-230 V, 50-60 Hz, 18 W power supply unit, incl. country-specific adapter set
 - lead-free
 - Spout ring cannot be removed.
 - This product can help a building meet the requirements of Green Building Rating Systems, e.g. LEED®, BREEAM®, DGNB
- A minimum flow pressure of 3 bar is necessary for the HOT & COLD WATER DISPENSER to work perfectly in conjunction with a hot water tank and filter.**
In addition, the installation must be above a kitchen sink.
The filter cartridge must be changed every six months. The installation instructions contain further information for guidance.
Detailed planning information and technical data can be found at www.dornbracht.com/professional

A minimum flow pressure of 3 bar is necessary for the HOT & COLD WATER DISPENSER to work perfectly in conjunction with a hot water tank and filter.

In addition, the installation must be above a kitchen sink.

The filter cartridge must be changed every six months. The installation instructions contain further information for guidance.

Detailed planning information and technical data can be found at www.dornbracht.com/professional

	Champagne (22kt Gold)	17 861 625-47
	Chrome	17 861 625-00
	Brushed Platinum	17 861 625-06
	Platinum	17 861 625-08
	Durabrand (23kt Gold)	17 861 625-09
	Dark Chrome	17 861 625-19
	Brushed Durabrand (23kt Gold)	17 861 625-28
	Matte Black	17 861 625-33
	Brushed Champagne (22kt Gold)	17 861 625-46
	Brushed Chrome	17 861 625-93
	Brushed Dark Platinum	17 861 625-99

Required miscellaneous



Hot water tank incl. filter - 12 892 970 90

17 861 625

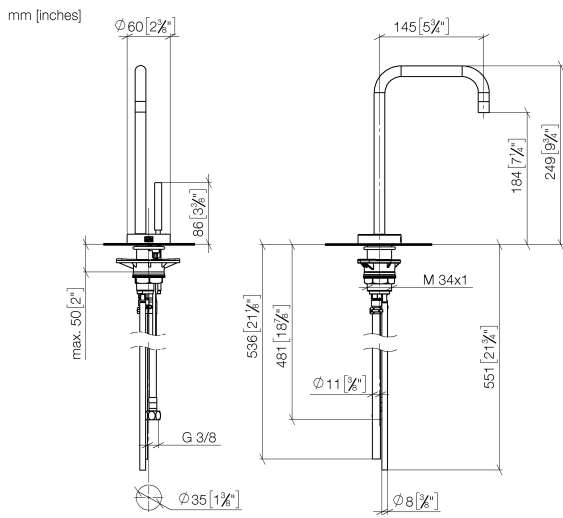

Flow rate chart

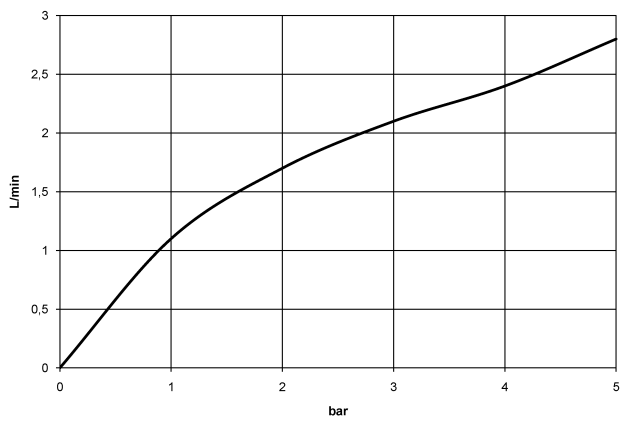

Certificates

IAPMO_N-4976. GDV_0400297. IAPMO_6397.

17 861 625

